

SINCE 1989

**Clōsma**<sup>®</sup>  
Railing Systems

**All Glass**<sup>™</sup>  
Railing Systems  
Alluminium Railing System

**C - RAIL**  
STAINLESS STEEL RAILING



## Aluminium & Stainless Steel Railing Solutions

EDITION : 5

# CONTENTS



- Continuous Railing System
- Aluminium Spigot Fitting
- Flushed Handrail With Channel System

Page 05-12



- 10mm / 12mm Thick Balustrades
- Railing System With Supporting Mid Rails
- Railing System With Glass
- Round / Square Top Mounted Balustrades With Glass Holders

Page 13-35

## CUSTOMIZED RAILING SYSTEMS

S.S. 304 Railing Accessories

**PROJECT:**  
**INDIRA  
GANDHI  
INTERNATIONAL  
AIRPORT**

TERMINAL 2,  
NEW DELHI





Welcome to Closma Aluminium Glass Railing System. Closma is leading solution provider of Architectural Glass Railing Systems.

#### **VALUE FOR MONEY**

We want long term relationships with our customers. We understand the importance of value for money and will always look to price our products competitively.

#### **SALES FROM STOCK**

Our products are immediately available from stock. We will deliver anywhere in India with in a short number of days.

#### **SAFETY**

Safety is and always will be our number one priority. All our products are rigorously tested and sold with certification.

#### **TECHNICAL SUPPORT**

We offer our customers technical support whenever and wherever the need it, including site visits.

#### **INSTALLATION**

We select our products on the basis that not only are they aesthetically pleasing but just as importantly are quick easy and cost effective to install.

**All Glass™**  
**Railing Systems**

**All Glass™**  
Railing Systems

**Closma®**  
Railing Systems





**CBL(A)-AG-01**  
CONTINUOUS PROFILE

12FT/ LENGTH 45 x 121mm

**Specification**

- 1) System For 12 mm Glass
- 2) Support Glass Height Up to 3.5 Feet
- 3) Profile Length : 12 Ft.

**CBL(A)-AG-01**  
CONTINUOUS PROFILE

**Finish**

MILL
BLACK
GREY
CHAMPAGNE



Full Endcap

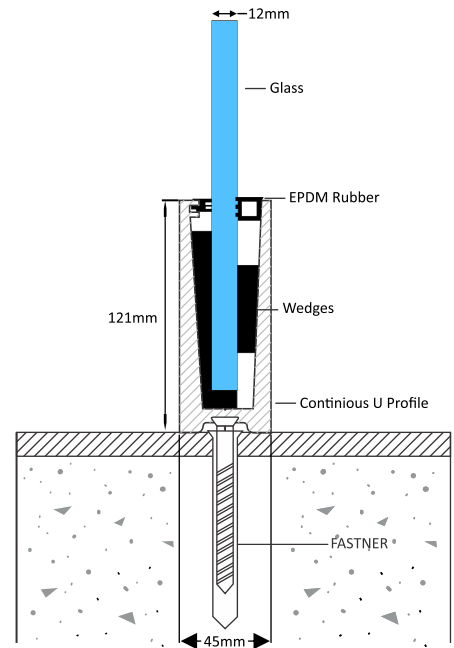

**CBL(A)-AG-02**  
CONTINUOUS PROFILE

15FT/ LENGTH 55 x 77mm

**Specification**

- 1) System For 12 mm Glass
- 2) Support Glass Height Up to 3 Feet
- 3) Profile Length : 15 Ft.

**Finish**

BLACK
GREY
CHAMPAGNE
WOODEN

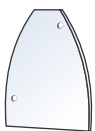

Full Endcap

Mill Finish



Locking Patti

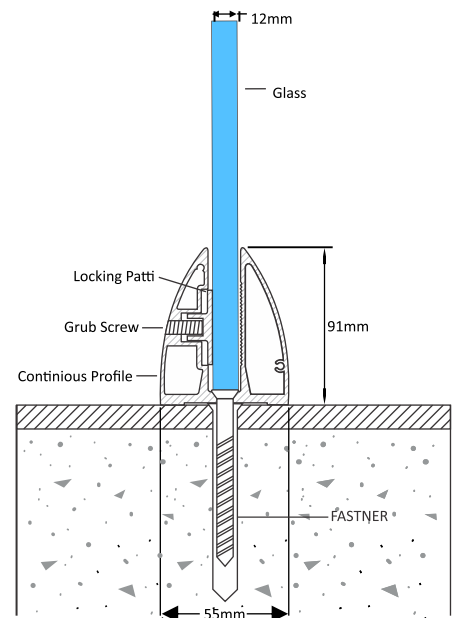



**CBL(A)-AG-03**  
CONTINUOUS PROFILE

15FT/ LENGTH 40 x 80 mm

**Specification**

- 1) System For 12 mm Glass
- 2) Support Glass Height Up to 3 Feet
- 3) Profile Length : 15 Ft.

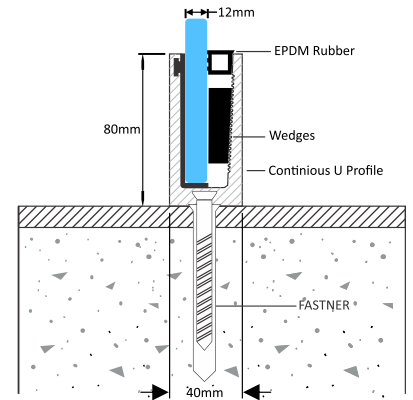

Also can be Conceal in Floor

Finish
MILL
BLACK
GREY
CHAMPAGNE

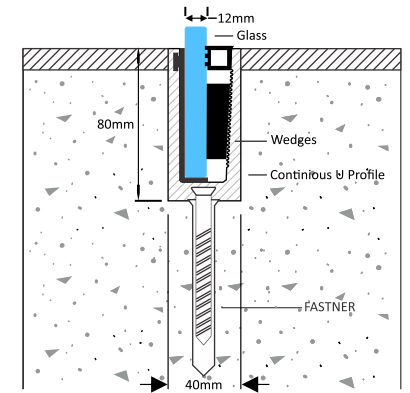

**60MM FLAT PROFILE**

**CBL(A)-AG-10**  
60MM FLAT PROFILE

15FT/ LENGTH 33 x 60 mm

**Specification**

- 1) System For 12 mm Glass
- 2) Support Glass Height Up to 3 Feet
- 3) Profile Length : 15 Ft.



Finish
MILL
BLACK
GREY
CHAMPAGNE

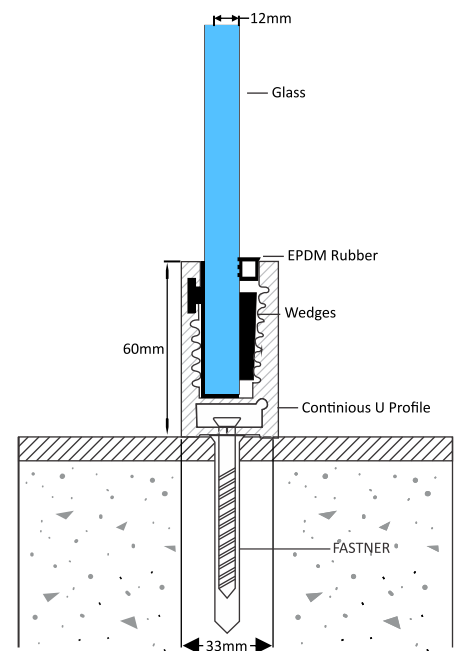



**CBL(A)-AG-04**  
CONTINUOUS PROFILE

15FT/ LENGTH 95 x 130 mm

**Specification**

- 1) System For 12 mm Glass
- 2) Support Glass Height Up to 3 Feet
- 3) Profile Length : 15 Ft.
- 4) With Colour Aluminium Magic Plate

**CBL(A)-AG-04**  
CONTINUOUS PROFILE

**Finish**

MILL
BLACK
GREY
CHAMPAGNE

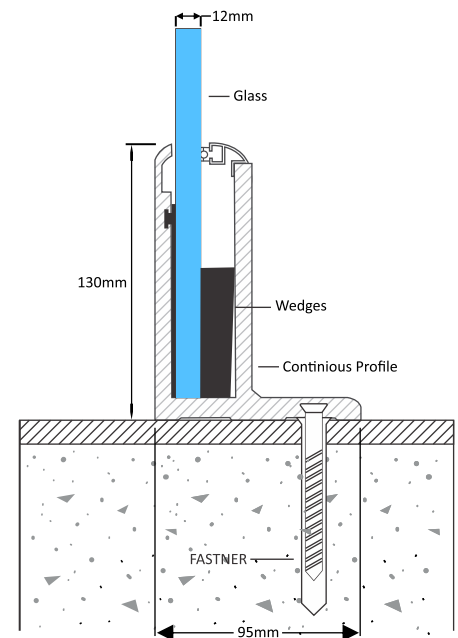



**CBL(A)-AG-08**  
CONTINUOUS PROFILE

**Specification**

- 1) System For 12 mm Glass
- 2) Support Glass Height Up to 3 Feet
- 3) Bracket Size : 85mm & 110mm
- 3) Profile Length : 12 Ft.



**CBL(A)-AG-08 (70MM) PC.**  
MILL Finish

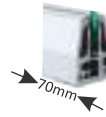

**CBL(A)-AG-08 (140MM) PC.**  
MILL Finish

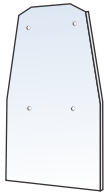
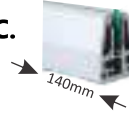

Full Endcap

**CBL(A)-AG-08-SCP-12**

Side Cover Plate 12ft./Length (Pair Price) Left / Right Cover Plate

**Finish**

- BLACK
- GREY

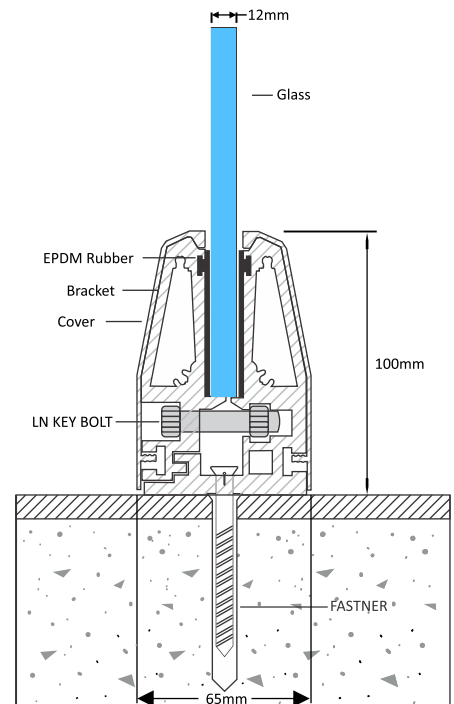
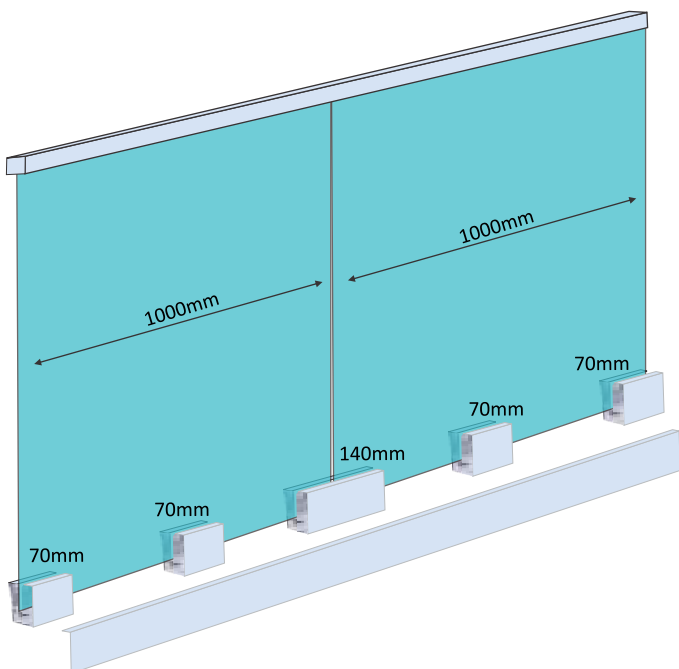



**CBL(A)-AG-07**  
RAILING BRACKET

80 x 95 mm

**Specification**

- 1) System For 12 mm Glass
- 2) Support Glass Height Up to 3 Feet

**CBL(A)-AG-07**  
RAILING BRACKET

**Finish**

- BLACK
- GREY

**T BRACKET**

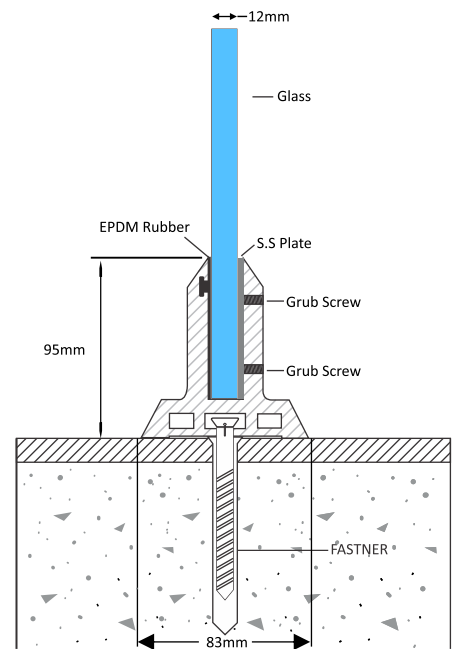

**CBL(A)-AG-09**  
RAILING BRACKET

59 x 114 mm

**Specification**

- 1) System For 12 mm Glass
- 2) Support Glass Height Up to 3 Feet

**Finish**

- BLACK
- GREY

**V BRACKET**

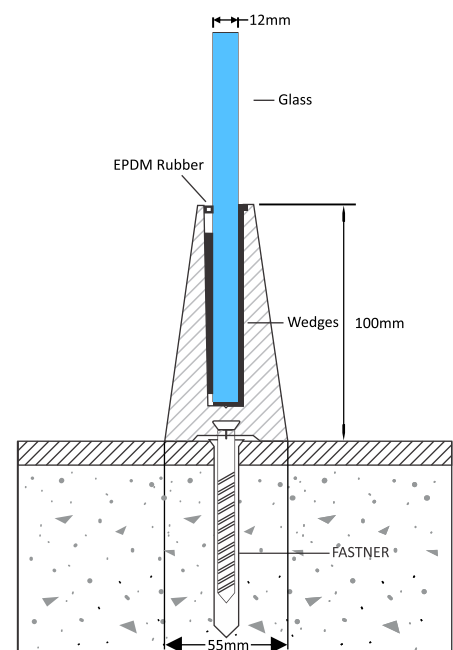



**CBL(A)-HR-01**  
50MM ROUND

Mill Finish  
Dimension : Dia 50 mm

Finish	Unit
BLACK	R. FT.
GREY	R. FT.
CHAMPAGNE	R. FT.

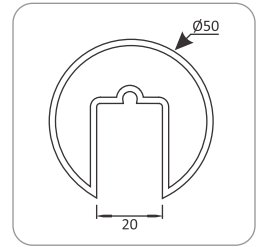

15FT./LENGTH

CBL(A)-HR-01-S



Endcap

CBL(A)-HR-01-90°



Jointer 90°

CBL(A)-HR-01-W



Wall Conceal

CBL(A)-HR-01



Jointer 180°

CBL(A)-HR-01-Gasket



EPDM GASKIT  
UNIT : FT



**CBL(A)-HR-02**  
50 x 50MM SQUARE

Mill Finish  
Dimension : 50 x 50 mm

Finish	Unit
BLACK	R. FT.
GREY	R. FT.
CHAMPAGNE	R. FT.

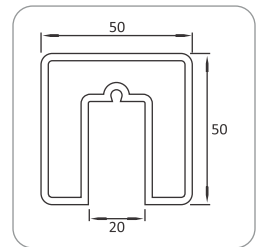

15FT./LENGTH

CBL(A)-HR-02-S



Endcap

CBL(A)-HR-02-90°



Jointer 90°

CBL(A)-HR-02-W



Wall Conceal

CBL(A)-HR-02



Jointer 180°

CBL(A)-HR-02-Gasket



EPDM GASKIT  
UNIT : FT



**CBL(A)-HR-03**  
40 x 40MM SQUARE

Mill Finish  
Dimension : 40 x 40 mm

Finish	Unit
BLACK	R. FT.
GREY	R. FT.
CHAMPAGNE	R. FT.

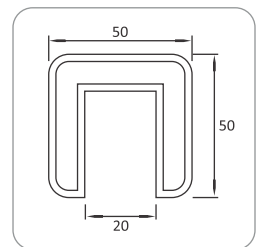

15FT./LENGTH

CBL(A)-HR-03-S



Endcap

CBL(A)-HR-03-90°



Jointer 90°

CBL(A)-HR-03-W



Wall Conceal

CBL(A)-HR-03



Jointer 180°

CBL(A)-HR-03-Gasket



EPDM GASKIT  
UNIT : FT



**CBL(A)-HR-04**  
25 x 25MM SQUARE

**Mill Finish**  
Dimention : 25 x 25 mm

**15FT./LENGTH**

Finish	Unit
BLACK	R. FT.
GREY	R. FT.
CHAMPAGNE	R. FT.
WOODEN	R. FT.

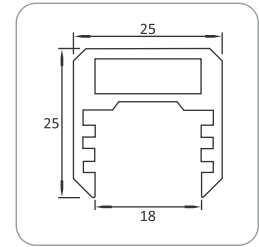

CBL(A)-HR-04-S



Endcap

CBL(A)-HR-04-90°



Jointer 90°

CBL(A)-HR-04-W



Wall Conceal

CBL(A)-HR-04



Jointer 180°

CBL(A)-HR-04-Gasket



EPDM GASKIT  
UNIT : FT



**CBL(A)-HR-06**  
65 x 40MM TRIANGLE

**Mill Finish**  
Dimention : 65 x 40 mm

**15FT./LENGTH**

Finish	Unit
BLACK	R. FT.
GREY	R. FT.

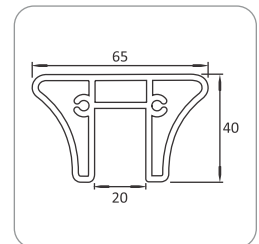

CBL(A)-HR-06-S



Endcap

CBL(A)-HR-06-90°

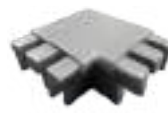

Jointer 90°

CBL(A)-HR-06-W



Wall Conceal

CBL(A)-HR-06



Jointer 180°

CBL(A)-HR-06-Gasket

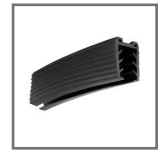

EPDM GASKIT  
UNIT : FT

## SHADES ON ORDER



**CASD-2218N**  
Steel Bronze-01 (Matte)



**CASD-2103N**  
Golden Bronze (Satin)



**CASD-A53N**  
Champagne (Matte)

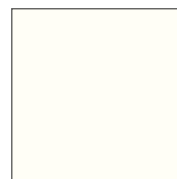

**CASD-18AN**  
Pearl White

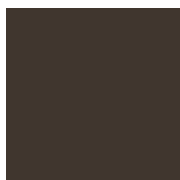

**CASD-28BN**  
Anodic Bronze ||| (Matte)



**CASD-242N**  
Grey



**CASD-333N**  
Black Matte

### Universal Jointer

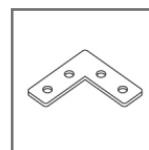

Jointer 90° (Pati)

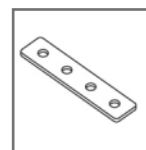

Jointer 180° (Pati)

### Chemical



### Fastner



### Brackets



## Aluminium Railing Acc.

# CLOSMa, the architect of inspiring projects



**BRIGHTNESS...  
THROUGH GLASS**

## CBL(A)-1900

Floor Mounted Glass Holder - With Holes

CP  
SSS

- Solid Stainless Steel Grade 304
- Suitable For glass 12 ~ 15mm Glass
- Teflon Packing for glass protection
- Can be used with accessories also
- Finish : SSS / CP

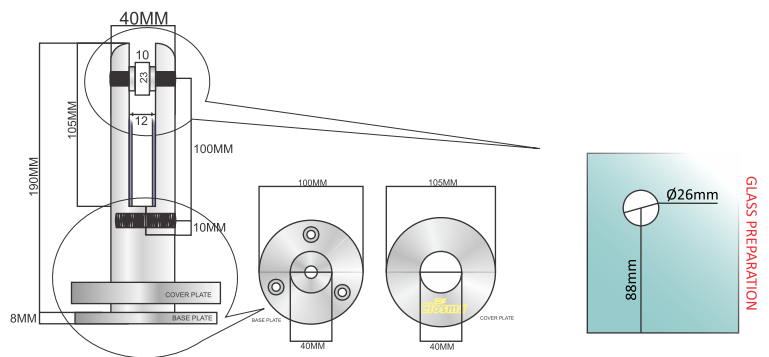

## CBL(A)-1902

Floor Mounted Glass Holder - With Holes

CP  
SSS  
BLACK

- Solid Stainless Steel Grade 304
- Suitable For glass 10 ~ 12mm Glass
- Teflon Packing for glass protection
- Can be used with accessories also
- Also Comes With Base Cover Plate & Fastners
- Finish : SSS / CP
- No Holes Required in glass



COMES WITH S.S BOTTOM COVER

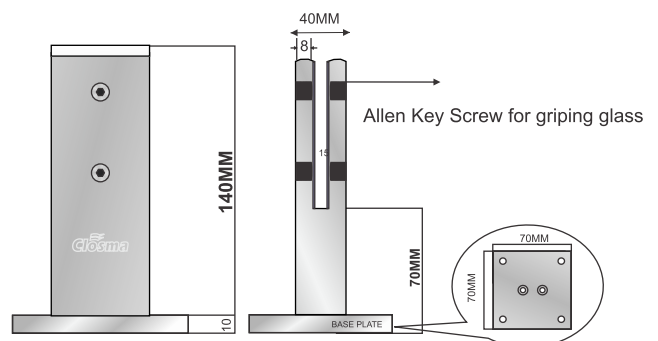

**CBL(A)-1903** New

Floor Mounted Glass Holder

**CP**  
**SSS**

- Solid Stainless Steel Grade 304
- Suitable For glass 10 ~ 12mm Glass
- Teflon Packing for glass protection
- Can be used with accessories also
- Also Comes With Base Cover Plate & Fastners
- Finish : SSS / CP
- **No Holes Required in glass**



COMES WITH S.S BOTTOM COVER

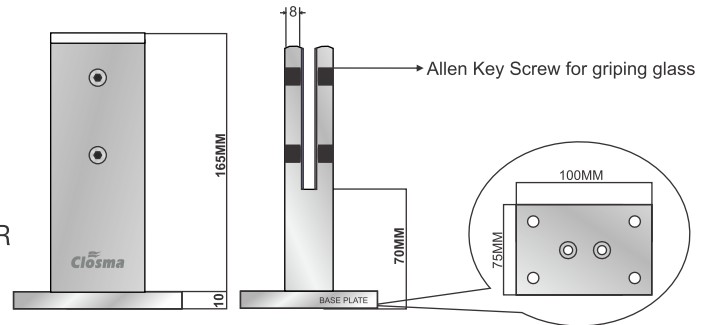

**CBL(A)1904- ECO** New

Floor Mounted Glass Holder

**CP/SSS**  
**BLACK**

- Solid Stainless Steel Grade 304
- Suitable For glass 10 ~ 12mm Glass
- Teflon Packing for glass protection
- Can be used with accessories also
- Finish : SSS / CP
- **No Holes Required in glass**

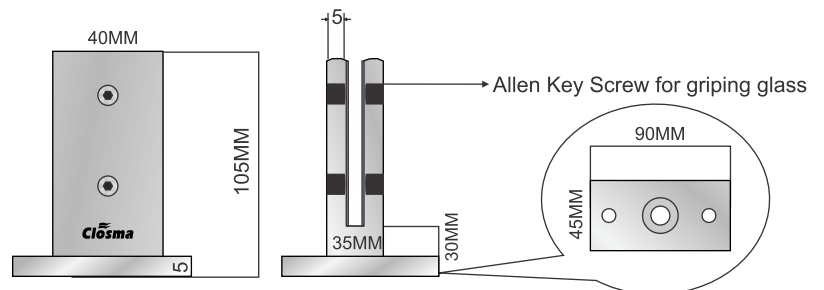

**CBL(A)-1905**

Floor Mounted Glass Holder - With Holes

**CP**  
**SSS**

- Solid Stainless Steel Grade 304
- Suitable For glass 10 ~ 12mm Glass
- Teflon Packing for glass protection
- Can be used with accessories also
- Finish : SSS / CP
- **No Holes Required in glass**

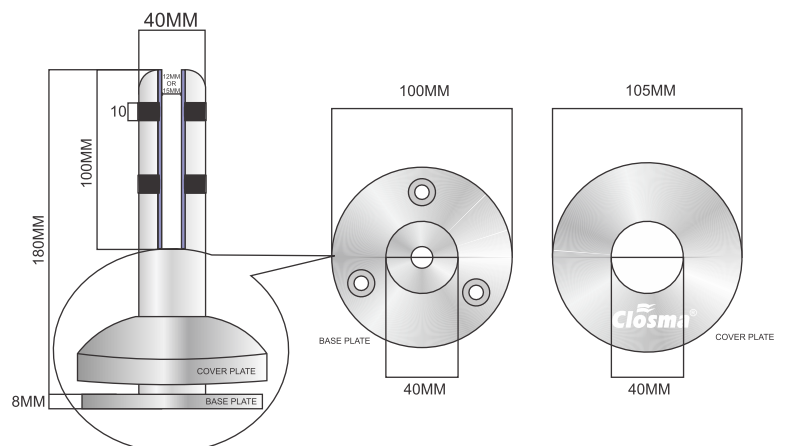



**CBL(A)-1907** New

Floor Mounted Glass Holder - Without Holes

CP  
SSS



- Unique Sleek design
- Solid Stainless Steel Grade 304
- Suitable For glass 10 ~ 12mm Glass
- Teflon Packing for glass protection
- Can be used with accessories also
- Finish : SSS
- No Holes Required in glass

With hole Available on request

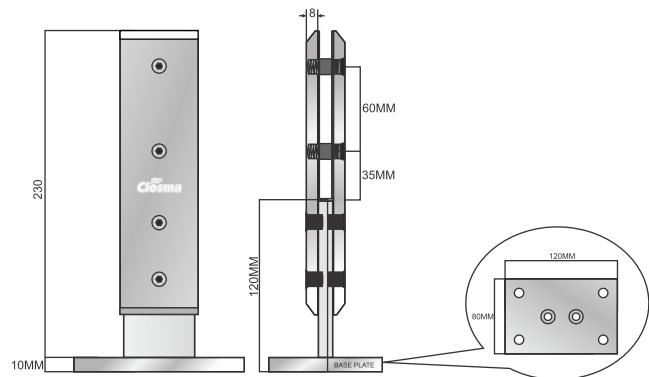

**CBL(A)-1912** New

Floor Mounted Glass Holder - With Holes

CP  
SSS

- Solid Stainless Steel Grade 304
- Suitable For glass 12 ~ 15mm Glass
- Teflon Packing for glass protection
- Can be used with accessories also

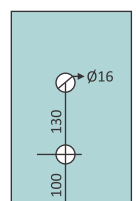
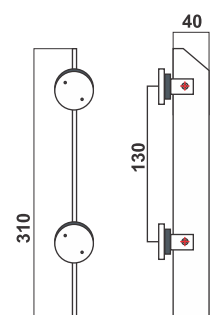

**CBL(A)-1916** New

Floor Mounted Glass Holder - MINI Spigot

CP  
SSS

- Solid Stainless Steel Grade 304
- Suitable For glass 10 ~ 12mm Glass
- Teflon Packing for glass protection
- Can be used with accessories also
- Holes Required in glass

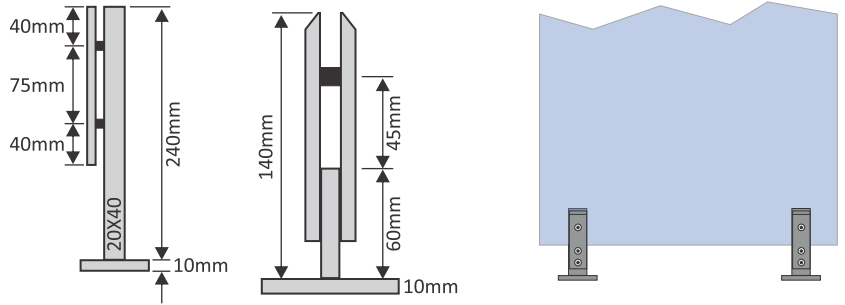

**CBL(A)-1917** New

Floor Mounted Glass Holder - MINI Spigot

CP  
SSS

- Solid Stainless Steel Grade 304
- Suitable For glass 10 ~ 12mm Glass
- Teflon Packing for glass protection
- Can be used with accessories also
- Holes Required in glass

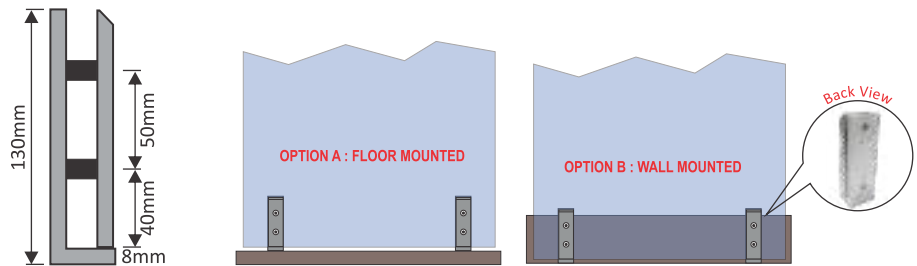

**CBL(A)-1918** New

Floor Mounted Glass Holder - MINI Spigot

CP  
SSS

- Solid Stainless Steel Grade 304
- Suitable For glass 10 ~ 12mm Glass
- Teflon Packing for glass protection
- Can be used with accessories also
- No Holes Required in glass

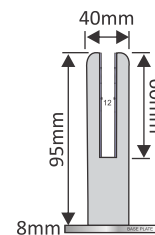

OPTION A : WITH BASE PLATE



## CBL(A)-1826

Round Railing Stand Offs - Adjustable

- Solid Stainless Steel Grade 304
- Backcup Threaded for Distance adjusting
- Suitable for 12mm ~ 15mm Glass Thickness
- Finish : SSS / CP



SSS



BM



BG

### Reference Drawing

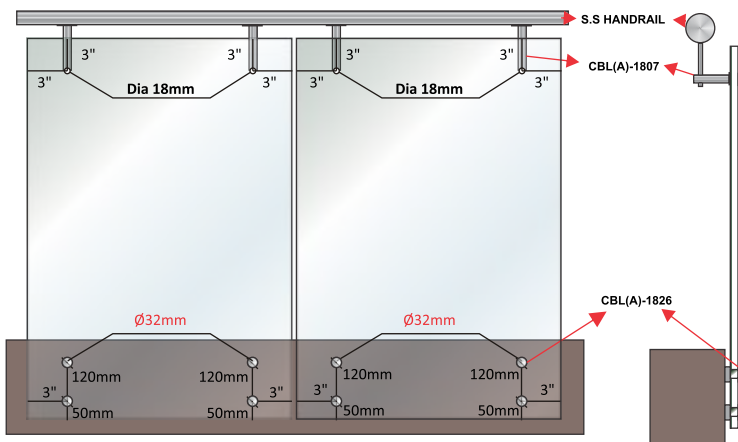

Front View



Side View



Back View

### Back Cup Threaded for Distance adjusting

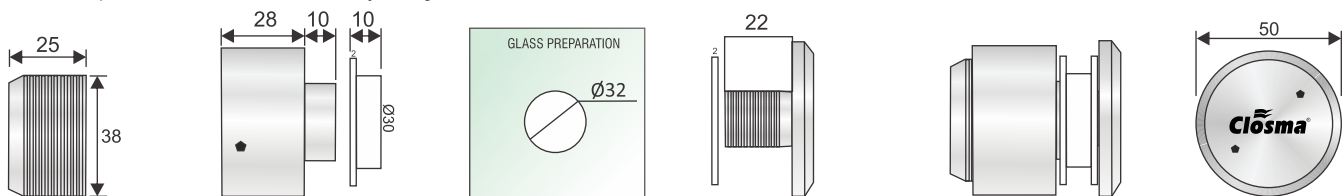

## CBL(A)-1836

**38mm**

Round Railing Stand Offs - Non Adjustable

**SSS  
BLACK**

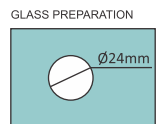
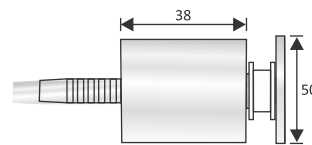

- Solid Stainless Steel Grade 304
- Fixed Type (Without Adjustment)
- Teflon Washers for Glass Protection
- Available in Ø50mm
- Finish : SSS / CP
- Comes With 3" Bolt

## CBL(A)-1837

Round Railing Stand Offs - Non Adjustable



- Solid Stainless Steel Grade 304
- Adjustment
- Teflon Washers for Glass Protection
- Finish : SSS / CP

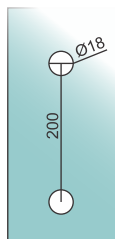

Glass Preparation Details

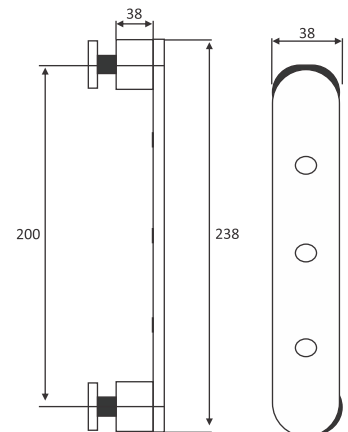
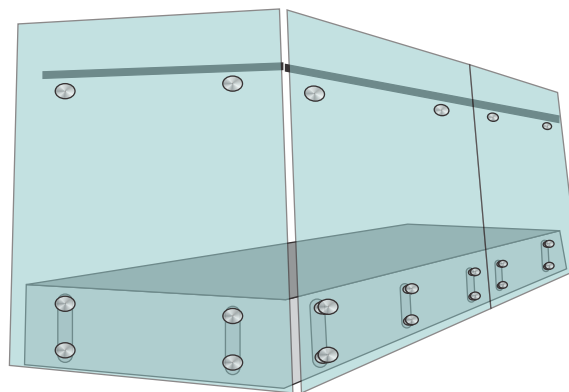

### ACCESSORIES CAN BE USED WITH

#### CBL(A)-1807



#### CBL(A)-1839



#### CBL(A)-1802



## CBL(A)-1840 **Eco** New

Railing Stand-Offs With Base Plate - **Economy**

**SSS**  
**Black**



**Normal Hole Ø22mm**  
With 3" threaded bolt

- Solid Stainless Steel Grade 304
- **Fixed Type (Without Adjustment)**
- Teflon Washers for Glass Protection
- Finish : SSS / CP

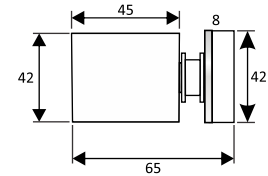

## CBL(A)-1841 New

Railing Stand-Offs - **Economy**

**Normal Hole Ø22mm**



- Solid Stainless Steel Grade 304
- **Articulated Type (Adjustable)**
- Teflon Washers for Glass Protection
- Finish : SSS / CP

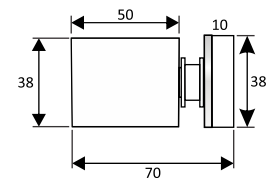

## CBL(A)-1846

Railing Stand-Offs - Square Series **Premium**

**Normal Hole Ø22mm**



- Solid Stainless Steel Grade 304
- **Fixed Type (Without Adjustment)**
- Teflon Washers for Glass Protection
- Finish : SSS / CP

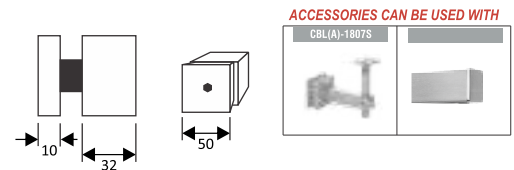

## CBL(A)-1848

Railing Stand-Offs - Round Series

**Normal Hole Ø22mm**



- Solid Stainless Steel Grade 304
- **Fixed Type (Without Adjustment)**
- Teflon Washers for Glass Protection
- Finish : SSS / CP

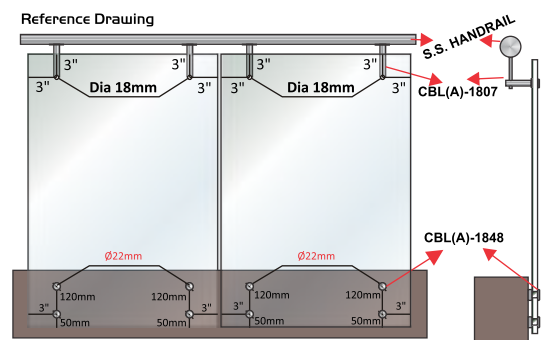
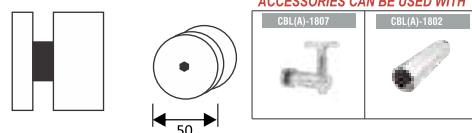

## CBL(A)-1807

Ø50 Handrail Connector *With Glass*

CP/SSS

BM

BG

COMMERCIAL SERIES  
Railing Systems



- Stainless Steel Grade 304
- Angle & Height adjustable
- Heavy Duty Fitting
- Finish : SSS / CP

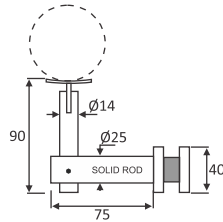

## CBL(A)-1839

Ø50 Handrail Connector *With Glass*

*Designer Series*

CP

SSS



- Stainless Steel Grade 304
- Angle & Height adjustable
- Heavy Duty Fitting
- Finish : SSS / CP

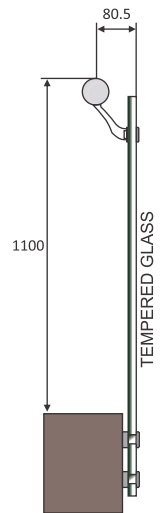

## CBL(A)-1838

**New**

*Economy Series*

GLASS TO HANDRAIL SQUARE SERIES



- Stainless Steel Grade 304
- Angle & Height adjustable
- Heavy Duty Fitting
- Finish : SSS / CP

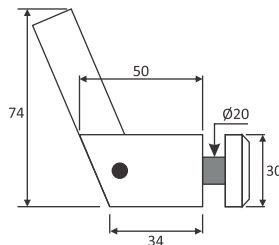

## CBL(A)-1807S

**New**

*Designer Series*

GLASS TO HANDRAIL SQUARE SERIES



- Stainless Steel Grade 304
- Angle & Height adjustable
- Heavy Duty Fitting
- Finish : SSS / CP

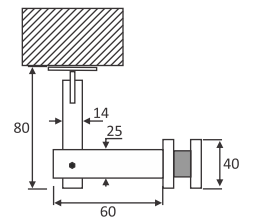

## CBL(A)-1832

Square Slotted Handrail S.S 304

CP/SSS  
BM

(Available in 20 Ft Length)

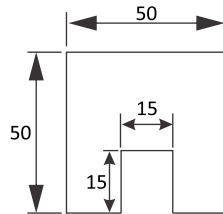

- Stainless Steel Grade 304
- Wall Thickness 3mm
- Inside Gap 14mm Suitable for 12mm Glass

## CBL(A)-1832 L

Handrail Joint 90°

CP/SSS  
BM



- Stainless Steel Grade 304

## CBL(A)-1832 W

Wall To Handrail

CP/SSS  
BM



- Stainless Steel Grade 304
- Wall Thickness 3mm
- Inside Gap 14mm Suitable for 12mm Glass

## CBL(A)-1832 S

Handrail Joint 180°

CP/SSS  
BM

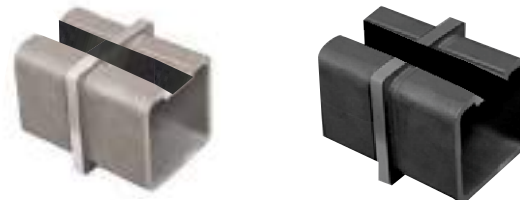

- Stainless Steel Grade 304

## CBL(A)-1832A S

Handrail Endcap

CP/SSS  
BM

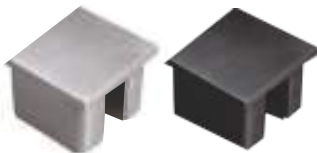

- Stainless Steel Grade 304
- Wall Thickness 3mm
- Inside Gap 14mm Suitable for 12mm Glass

## CBL(A)-1832 AD

Handrail Joint **Adjustable**

CP/SSS  
BM

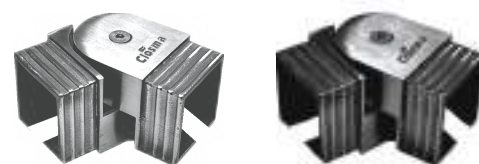
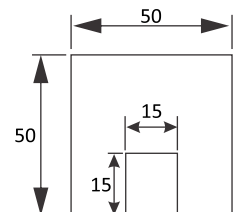

## CBL(A)-GASKET

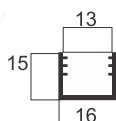

- High Quality Flexible Rubber Gasket
- Suitable for 12mm Glass
- Height 15mm

## CBL(A)-1835

RECTANGULAR PIPE SS. 304

CP/SSS

BM

## CBL(A)-1835 L

Handrail Joint 90°

CP/SSS

BM

(Available in 20 Ft Length)

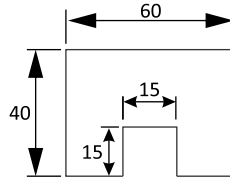
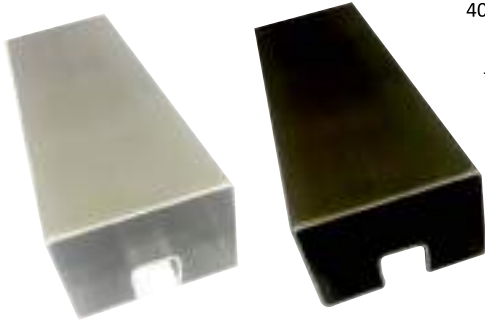

- Stainless Steel Grade 304
- Wall Thickness 3mm
- Inside Gap 14mm Suitable for 12mm Glass

- Stainless Steel Grade 304
- Wall Thickness 3mm
- Inside Gap 14mm Suitable for 12mm Glass

## CBL(A)-1835 W

Wall To Handrail

CP/SSS

BM

## CBL(A)-1835 S

Handrail Joint 180°

CP/SSS

BM



- Stainless Steel Grade 304
- Wall Thickness 3mm
- Inside Gap 14mm Suitable for 12mm Glass



- Stainless Steel Grade 304
- Wall Thickness 3mm
- Inside Gap 14mm Suitable for 12mm Glass

## CBL(A)-1835A S

Handrail Endcap

CP/SSS

BM

## CBL(A)-GASKET



- Stainless Steel Grade 304
- Wall Thickness 3mm
- Inside Gap 14mm Suitable for 12mm Glass

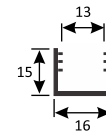

- High Quality Flexible Rubber Gasket
- Suitable For 12mm Glass
- Height 15mm

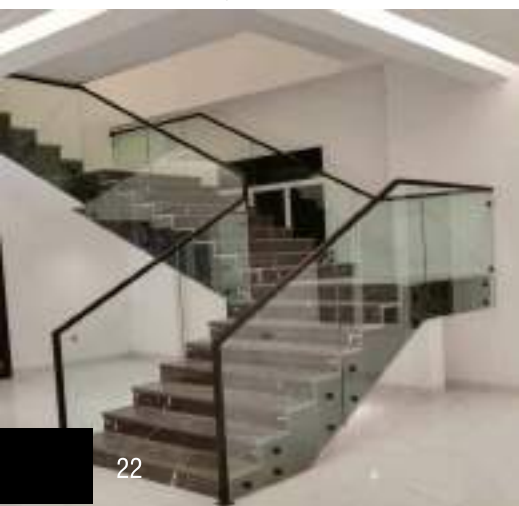



DEEP...  
INSIDE

### CBL(A)-1833

Ø50mm Slotted Handrail S.S 304

CP/SSS

BM

(Available in 20 Ft Length)

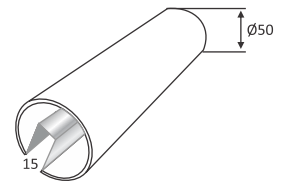

- Stainless Steel Grade 304
- Wall Thickness 3mm
- Inside Gap 14mm Suitable for 12mm Glass
- Outer size 30mm x 15mm
- Finish : SSS / CP

### CBL(A)-1833 L

Handrail Joint 90° For Ø50mm

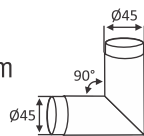

CP/SSS  
BM

### CBL(A)-1833 AD

Ø50mm Handrail Joint 90°

Adjustable

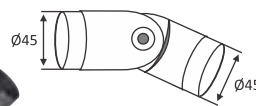

CP/SSS  
BM

### CBL(A)-1833A S

Handrail Endcap For Ø50mm

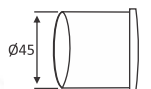

CP/SSS  
BM

### CBL(A)-1833 W

Wall To Handrail For Ø50mm

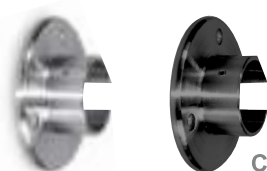
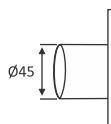

CP/SSS  
BM

### CBL(A)-1833 S

Handrail Joint 180° For Ø50mm



CP/SSS  
BM

### CBL(A)-GASKET

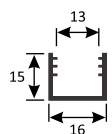



**CBL(A)-1802**  
Ø50mm Handrail

CP  
SSS

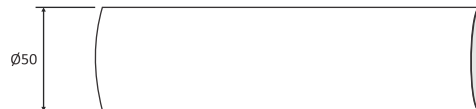

- Stainless Steel Grade 304
- 2mm Wall Thickness
- Hairline Buffed / Polished
- Finish : SSS / CP

**CBL(A)-1802 L**  
Ø50mm Handrail Joint 90°

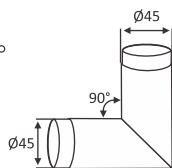

- Stainless Steel 304

**CBL(A)-1802 FL** Adjustable  
Ø50mm Handrail Joint 90°

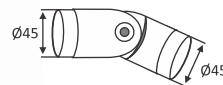

- Stainless Steel 304

**CBL(A)-1802 W** Also Comes with cover  
Ø50mm Handrail End  
To Wall

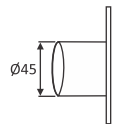

- Stainless Steel 304

**CBL(A)-1802 S**  
Ø50mm Handrail Joint 180°

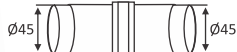

- Stainless Steel 304

**CBL(A)-1802A S** Cap Only  
Ø50mm Handrail End

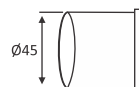

- Stainless Steel 304

## CBL(A)-1806

Wall To Handrail Side Mounted

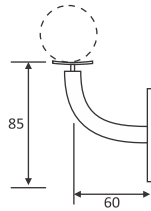

AVAILABLE FOR

CBL(A)-1802



CBL(A)-1822



- Stainless Steel Grade 304
- Angle & Height Fixed
- Heavy Duty Fitting
- Finish : SSS / CP

## CBL(A)-1808

Economy Series

Wall To Handrail

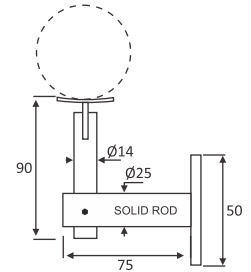

AVAILABLE FOR

CBL(A)-1802



CBL(A)-1822



- Stainless Steel Grade 304
- Angle & Height Fixed
- Heavy Duty Fitting
- Finish : SSS / CP

## CBL(A)-1834

'U' Channel For Railing

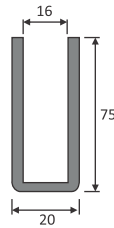

CBL(A)-1807



CBL(A)-1802



- Stainless Steel Grade 304
- Wall Thickness 3mm
- Inside Gap 14mm Suitable for 12mm glass
- Outer size 80mm x 20mm
- Finish : SSS



ART OF MODERNIZATION

## CBL(A)-1834S

S.S 'U' Channel

10 Ft. Length

SSS

BM

BG

RG

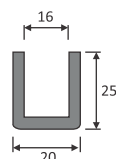

- Stainless Steel Grade 304
- Inside Gap 14mm Suitable for 12mm glass
- Finish : SSS

### APPLICATIONS

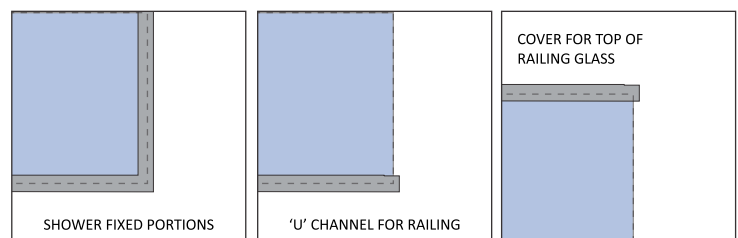

**CBL(A)-1705** Rectangle Pipe

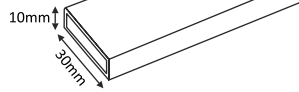

• Stainless Steel Grade 304

**CBL(A)-1805**

Ø19mm Mid-rail  
Ø16mm Mid-rail  
Ø12mm Mid-rail



• Stainless Steel Grade 304

**CBL(A)-1801** Wall To Handrail

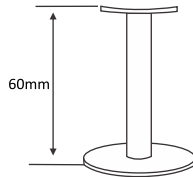

• Stainless Steel Grade 304

**CBL(A)-1820** Glass to Glass Connector

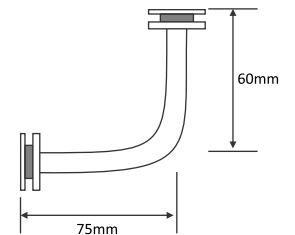

• Stainless Steel Grade 304

**CBL(A)-1828**

Glass Clamp  
Flat Base

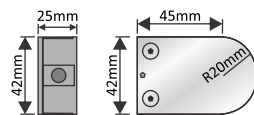
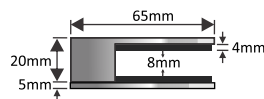

• Stainless Steel Grade 304

**CBL(A)-1829** Round Base

Glass Clamp

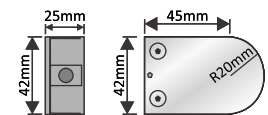
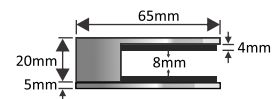

• Stainless Steel Grade 304

**CBL(A)-1824**

Glass Clamp  
Trape Zoid

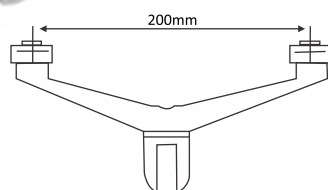

• Stainless Steel Grade 304

GLASS HOLE Ø22MM

**CBL(A)-1825**

Balustrade Accessories

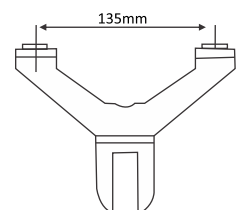

• Stainless Steel Grade 304

GLASS HOLE Ø22MM

## CBL(A)-1035

Top Mounted Round Balustrades With Four Point

- Stainless Steel Grade 304
- Finish : SSS

Ø50mm

Ø38mm

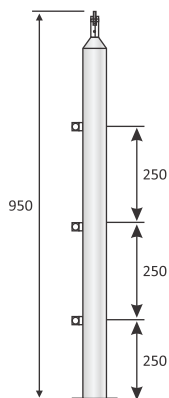

## CBL(A)-1041-4

Top Mounted Balustrade

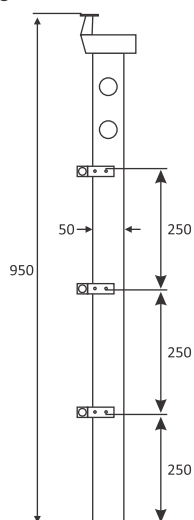

- Stainless Steel Grade 304
- Finish : SSS
- 10mm Thick
- Ø50mm Width

## CBL(A)-1012

Top Mounted Balustrade

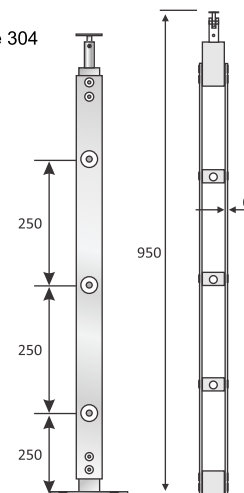

- Stainless Steel Grade 304
- Finish : SSS
- 6mm Thick

## CBL(A)-1017

Top Mounted Box Type Balustrades With Four Point

- 40 X 40 Square Balustre
- Stainless Steel Grade 304
- Finish : SSS



**STRENGTH & DESIGN**  
ITS POSSIBLE

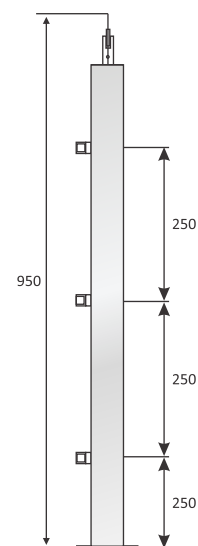

**CBL(A)-1044**

Solid Round Railing Post with Manet Fittings



CONCEPTS

Easy Installations...

No Welding Required



## CBL(A)-1040

Top Mounted Balustrades



- Stainless Steel Grade 304
- Finish : SSS
- 10mm Thickness
- Ø50mm Width

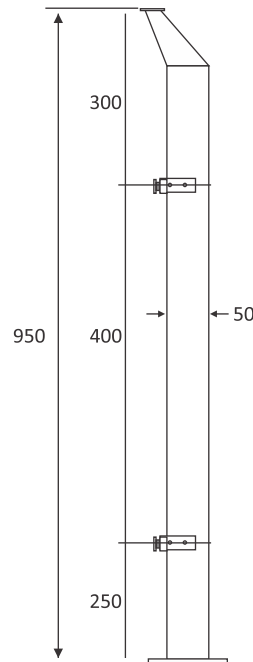

## CBL(A)-1045

Railing Concepts S.S. 304



Top View



## CBL(A)-1043

Railing Concepts S.S. 304



Side View

## CBL(A)-1017-2

Top Mounted Box Type Balustrade With Two Connector Plate



- 40 X 40 Square Balustre
- Stainless Steel Grade 304
- Finish : SSS

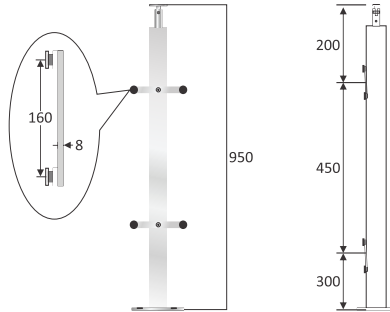

## CBL(A)-1017-2A

Top Mounted Box Type Balustrade With Glass Clamp

40MM 4 Connector  
40MM 2 Connector



## CBL(A)-1039-S

Top Mounted Box Type Balustrade



- Stainless Steel Grade 304
- Finish : SSS
- 10mm Thick
- Ø50mm Width





**CBL(A)-1035-2- Ø50** Side Mounted Box Type Balustrade With Two Trape Zoid

**50MM 4 Connector**  
**50MM 2 Connector**

**CBL(A)-1035-2- Ø50** Top Mounted Box Type Balustrade With Two Trape Zoid

**50MM 4 Connector**  
**50MM 2 Connector**



## CBL(A)-1032-2

Top Mounted Balustrades With Glass Clamps



- Stainless Steel Grade 304
- Finish : SSS
- 6mm Thick

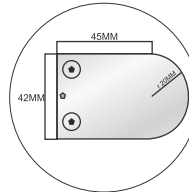

Two Glass Clamps  
Four Glass Clamps

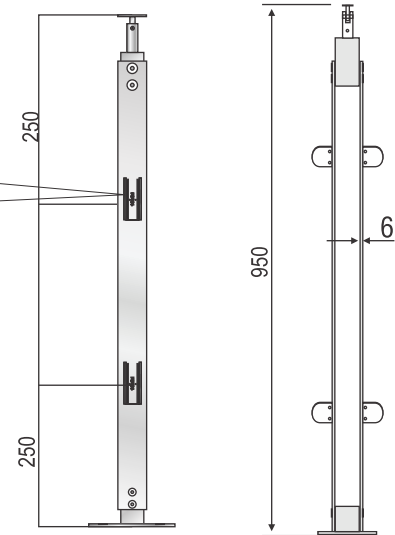

## CBL(A)-1041-2

Top Mounted Balustrade



- Stainless Steel Grade 304
- Finish : SSS
- 10mm Thick
- Ø50mm Width

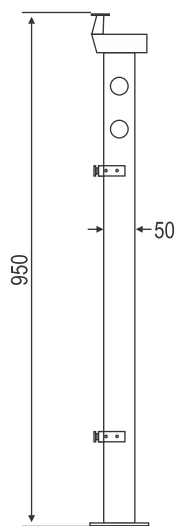

## CBL(A)-1042-2

Side Mounted Balustrade



- Stainless Steel Grade 304
- Finish : SSS
- 10mm Thick
- Ø50mm Width

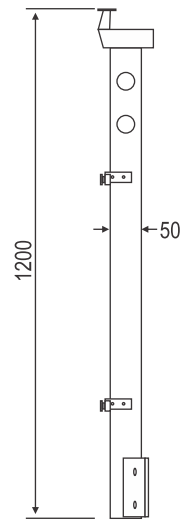

## CBL(A)-1029-2

Top Mounted Balustrades With Two Trape Zoid



Side View

- Stainless Steel Grade 304
- Finish : SSS
- 6mm Thick



DOUBLE BEAUTY...  
DOUBLE STRENGTH

**CBL(A)-1029 A**

Top Mounted Balustrades With Two Trape Zoid



- Stainless Steel Grade 304
- Finish : SSS
- 6mm Thick



**CBL(A)-1046**

Top Mounted Balustrades With Two Connector



- Stainless Steel Grade 304
- Finish : SSS
- 6mm Thick



**CBL(A)-1048**

Top Mounted Balustrades With Two Trape Zoid



## CBL(A)-1047

Top Mounted Balustrades With Two Trape Zoid

- Stainless Steel Grade 304
- Finish : SSS
- 12mm Thickness
- 75mm X 1050 mm
- For Project

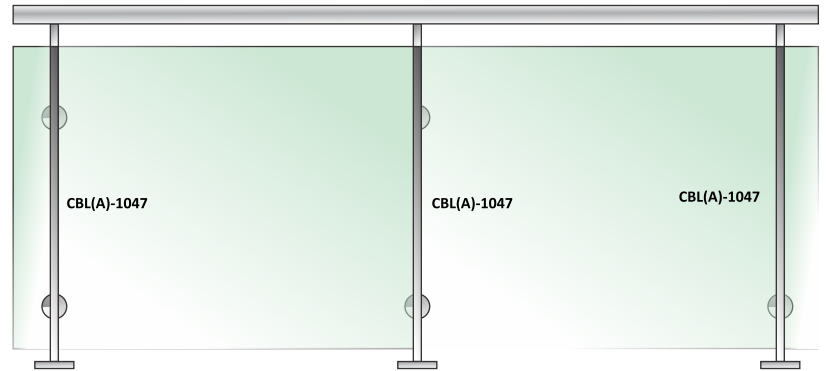



## CLOSMa INDIA

ARCHITECTURAL HARDWARE SOLUTION'S

D-16/4 Okhla Industrial Area  
Phase-1, New Delhi 110020, India



**Phone No.-**

01141731616  
01141661717  
09711922241 / 44 / 46

🌐 : [www.closma.com](http://www.closma.com)  
✉ : [info@closma.com](mailto:info@closma.com)  
📱 : [closmaindia](https://www.instagram.com/closmaindia)

INTERNAL PARTITION

SMART *Sliding*

WARDROBES & MORE

**Ralphie series** |  
Wardrobe Storage & Accessories

**Glass Fitting**  
by Closma